

# Magnesium interrelationships in ischemic heart disease: a review

Mildred S. Seelig, M.D., M.P.H., and H. Alexander Heggtveit, M.D.

Magnesium ions are essential for the maintenance of the functional and structural integrity of the myocardium. Experimental magnesium deficiency induces cardiac necrosis and enhances susceptibility to cardiotoxic agents; magnesium administration is protective. Recent investigations indicate that cellular loss of magnesium may be a basic biochemical mechanism in the evolution of myocardial lesions of diverse etiology. Other studies have shown that magnesium depletion influences coronary flow, blood clotting, and atherogenesis. This paper surveys the cardiovascular role of magnesium as it relates to certain facets of ischemic heart disease.

## *Loss of myocardial magnesium from ischemic hearts; anoxic hearts*

**Laboratory models.** Magnesium loss from the myocardium is one of the earliest changes found in several cardiomyopathic animal models (1, 2), including production of cardiac hypoxia by coronary ligation, by asphyxia, or by hemorrhagic hypotension (Table 1). The time lag after induction of hypoxia influences the degree of magnesium loss from the myocardial muscle. Cummings (3) and Cummings and Clark (4) first demonstrated loss of myocardial Mg (by 11 hr after a two-stage coronary ligation). Rigo et al. (5) found less loss of myocardial Mg in hearts analyzed 6 days after coronary ligation. Jennings (6) and Jennings and Shen (7) found that 40 min after temporary ligation there was almost one-third loss of myocardial Mg, which is not seen in hearts of dogs 1 hr after permanent ligation. Hochrein and co-workers' (8) study of hearts from guinea pigs in anoxic chambers demonstrated an early drop in magnesium that was

followed by a rise. Dogs with myocardial hypoxia secondary to hemorrhagic hypotension had increased losses of myocardial Mg from 135 to 180 min after the bleeding (9).

**Human material.** Ventricular muscle of patients who died of myocardial infarcts, reported by Iseri et al. (10), Meister and Schumann (11), Raab (12, 13) and Heggtveit et al. (14), had significantly lower magnesium content, particularly of the infarcted portion of the heart, as compared with magnesium levels in noninfarcted segments, and in hearts of patients who died of other causes (Table 2). In the study of Heggtveit et al. (14), hearts obtained at autopsy within 2 hr of death were examined grossly and microscopically. Mg was assayed in samples of left ventricular muscle by atomic absorption spectrophotometry. The mean myocardial Mg content of normal hearts from sudden traumatic deaths was 85.44 mEq/kg dry weight. Acutely infarcted heart muscle showed a 42% average decrease in Mg content, whereas the noninfarcted areas of the same hearts showed a 19% decrease. This latter diminution was comparable to that found in cases of sudden coronary death without detectable infarction. Skeletal muscle Mg levels did not differ significantly between the control and coronary groups. Laurendeau and DuRuisseau (15) re-

<sup>1</sup>Physician in Charge, Nutrition Metabolism, Goldwater Memorial Hospital, New York University Medical Center, New York, N.Y. 10017; Adjunct Associate Professor of Pharmacology, New York Medical College; and Research Associate, Pediatrics, Maimonides Medical Center, Brooklyn, N.Y. <sup>2</sup>Professor of Pathology, University of Ottawa, and Pathologist, Ottawa General Hospital, Ottawa, Ontario, Canada. Supported in part by grants from the Ontario Heart Foundation and by a grant from Mr. Julius Silver of New York, N.Y.

TABLE 1  
Loss of myocardial magnesium in cardiac hypoxia (laboratory models)

		Myocardial magnesium	
Coronary ligation (dogs) Cummings and Clark (4) Cummings (3)	After ligation		
	8-11 hr	Infarcted tissue:	30% ↓ (vs noninfarcted)
	8-11 hr	Infarcted ventricle:	49% ↓ } (vs sham-operated heart)
		Noninfarcted ventricle:	7% ↓ }
Rigo et al. (5)	6 days	Necrotic area:	21% ↓ } (vs intact area)
		Perinecrotic area:	9% ↓ }
Jennings (6); Jennings and Shen (7)	40 min, then reflow 60 min		29% ↓ (vs control heart)
			1% ↓ (vs control heart)
Asphyxia (guinea pigs) Hochrein et al. (8)	Duration, min		
	0.5		15% ↓ vs control
	1.0-1.5		31% ↓ vs control
	2.0		33% ↓ vs control
	2.5-4.0		34% ↓ vs control
	8.0		30% ↓ vs control
	10.0		25% ↓ vs control
10.5		7% ↓ vs control	
Hemorrhagic hypotension (dogs) Canepa et al. (9)	After bleeding	Right ventricle	Left ventricle
	135 min	8% ↓ vs control	14% ↓ vs control
	180 min	21% ↓ vs control	29% ↓ vs control

TABLE 2  
Loss of myocardial magnesium in cardiac ischemia (human)

		Percentage decrease in myocardial magnesium (from control, noninfarcted hearts: autopsy)
Myocardial infarcts		%
Iseri et al. (10)	Infarcted segment	42 ↓
	Noninfarcted segment	33 ↓
Meister and Schumann (11)	Infarcted heart	19 ↓
Raab and Kimura (12, 13)	Noninfarcted segment	32 ↓
Heggtveit et al. (14)	Infarcted segment	42 ↓
	Noninfarcted segment	19 ↓
Carbon monoxide poisoning		
Laurendeau and DuRuisseau (15)		23 ↓
DuRuisseau (16)		
Induced cardiac arrest in surgery		
Cardiac surgery		
Singh et al. (17)	Myocardial biopsy	2-19 ↓

ported that the hearts of 6 of 12 patients who died with foci of myocardial necrosis, but not necessarily with evidence of coronary thrombosis, had lowered levels of cardiac magnesium. This was most marked in diabetics with cardiomyopathy. A patient who died of carbon monoxide poisoning also showed substantial reduction in myocardial Mg (15, 16). How quickly such a loss of myocardial magnesium can occur is indicated by the findings of Singh et al. (17). They biopsied human hearts subjected to anoxic arrest for varying periods of time during cardiac surgery and found losses of myocardial magnesium ranging from 2 to 19%.

#### *Changes in plasma magnesium after myocardial infarction*

Patients with myocardial infarcts who were admitted to a hospital have been reported to have lowered serum magnesium levels by three groups of investigators (18-20) and to have levels not significantly different from controls by two (21, 22). Holtmeier (18) and Hughes and Tonks (19) took blood from acute myocardial infarct patients shortly after admission to the hospital and reported significantly lower

than control levels of plasma Mg. Nath and co-workers (20) reported low Mg levels the 1st week after infarction that fell further the 2nd week. Brown et al. (21) and Hyatt et al. (22) who reported no such decreases did not specify when in the course of the hospitalization for infarction the blood samples had been drawn. That these differences may be due to differences in time of testing after the ischemic event, as suggested by Lossnitzer (23), is supported by experimental findings. Nath et al. (20) reported that 1 hr after experimental myocardial infarction in dogs, serum Mg levels dropped markedly. Blood drawn 24 and 48 hr after the infarction had normal levels of serum Mg. Clark and associates (24) and Cummings (3) drew blood 8 to 11 hr after coronary ligation, at the time the ectopic rhythm was established (and when magnesium was leaving the heart) and found elevated plasma Mg. The elevations in serum Mg after repeated bleeding of rats, withdrawing up to 40% of total blood as reported by Goldsmith et al. (25) may well

have been derived from tissue stores. This is suggested also by the lower myocardial Mg in dogs with hemorrhagic hypotension (9).

*Protection against anoxia; ischemia by magnesium*

*Laboratory models.* There is laboratory evidence that magnesium salts protect against hypoxic damage to the heart (Tables 3A-C). Harris et al. (26) first demonstrated that either the sulfate or chloride of magnesium, given intravenously at a dosage of 1 mEq/liter suppressed the tachycardia and ectopic rhythm that had been caused by coronary ligation in 46 and 70% of the test dogs, respectively (Table 3A). Clark and Cummings (27) found that each of three successive infusions of MgSO<sub>4</sub> corrected the multifocal ventricular tachycardia caused by coronary ligation (B. B. Clark and J. R. Cummings, personal communication). Carden and Steinhaus (28) then reported that Locke-Ringer solution lacking magnesium ex-

TABLE 3A<sup>a</sup>  
Protection against structural and functional damage of cardiac hypoxia by magnesium salts (laboratory models)

Model and reference	Magnesium salts	Parameter
Dogs Harris et al. (26)	MgSO <sub>4</sub> } or } MgCl <sub>2</sub> } 1 mEq/liter, iv diluted to 20 cc, iv	Duration of suppression of the ectopic rate to ½ control rate. MgSO <sub>4</sub> : successful in 5 of 11 dogs (46%); MgCl <sub>2</sub> : successful in 9 of 13 dogs (70%)
Dogs Cummings (personal communication)	MgSO <sub>4</sub> : 100 mg/kg in 20 ml H <sub>2</sub> O, iv	Conversion of ventricular tachycardia to sinus rhythm
Dogs Carden and Steinhaus (28)	Locke-Ringer solution <sup>b</sup> Mg (0.05 mEq) Mg (2.00 mEq) Mg (0.05 mEq) in 0.9% NaCl Mg (2.00 mEq) in 0.9% NaCl Locke-Ringer solution <sup>b</sup> Mg (0.05 mEq) in 5% dextrose <sup>c</sup>	Protection against ventricular fibrillation No protection <sup>b</sup> ↑ Fibrillation <sup>c</sup>
Rabbits Weber et al. (30)	Mg + K aspartate iv (alone and in combination)	Protection against ECG changes
Rats Bajusz and Selye (29)	Mg or K chloride, oral pretreatment for 5 days preligation	Protection against cardiac necrosis (autopsy 14 days after ligation)

<sup>a</sup> Coronary ligation. <sup>b</sup> Ringer's solution without Mg. <sup>c</sup> Two milliequivalents Mg in 5% dextrose.

erted no effect on the ventricular fibrillation caused by coronary ligation, whereas the same solution, to which either 0.05 mEq or 2.0 mEq of Mg was added, exerted a protective effect. The same concentrations of Mg in 0.9% NaCl were similarly protective, as was 0.05% in 5% dextrose. (The larger concentration of Mg in the dextrose solution, however, actually increased fibrillation.) Bajusz and Selye (29) reported that oral administration of MgCl<sub>2</sub> or KCl for 5 days before coronary ligation protected rats against cardiac necrosis. Protection by Mg and K aspartates against hypoxia-induced electrocardiographic changes has been demonstrated by Weber et al. (30) in rabbits with ligated coronary arteries.

Lamarche et al. (31–33) found that iv Mg and K aspartates, but not the chloride salts, protected against ECG changes of anoxia in guinea pigs (Table 3B). Hochrein and Lossnitzer (34) tested only the aspartates in guinea pigs exposed to asphyxia and found that Mg and K aspartates, in combination, doubled the cardiac tolerance of anoxia. They found that the magnesium salt alone exerted a lesser degree of protection; the potassium salt alone was ineffective.

Studies with isolated hearts of rats, rabbits, and guinea pigs exposed to anoxic conditions have compared mixtures of Mg and K aspartate with Mg and K chloride (Table 3C). The aspartates exerted a greater protective effect than the chlorides against the ECG changes and reduction in systolic amplitude caused by anoxia (31–33, 35, 36). In these studies, the immediate effect of anoxia was to increase the rate of perfusion of the fluid (maintained under

constant pressure) through the coronary arteries of hearts being perfused with the balanced perfusion fluid (containing Mg and KCl). Rosen and associates (35) showed that when Mg and K aspartates were substituted for the chlorides, there were much greater rates of flow through the coronaries, whether the perfusion fluid was anoxic or normally oxygenated. Possibly this was a reflection of the greater systolic amplitude of the hearts perfused with fluids containing the aspartates (Fig. 1).

The foregoing studies reported protection by the magnesium salts (with and without potassium) that do not seem to be predominantly a function of a substantial effect on coronary blood flow. This is not to negate the known coronary dilation produced by even relatively low concentration of MgCl<sub>2</sub> (37, 38). The demonstration by Scott et al. (39) of the effect on coronary arterial resistance exerted by slight ionic changes of the blood (within normal limits) shows that such increases in plasma K<sup>+</sup> or Mg<sup>2+</sup> actively dilate the coronary vascular bed. A comparable study with hearts subjected to coronary ligation should provide valuable clarification of some of the dynamics by which the magnesium salts protected against ischemic damage in the experimental models just discussed. Studies designed to demonstrate the pharmacologic cardiac effects of hypermagnesemia are not relevant, either to the cardiac-protection laboratory studies or more particularly to the accumulating clinical data.

*Clinical evidence. Epidemiologic findings.* Kobayashi (40) first demonstrated a relationship between vascular disease and the hardness of drinking water, showing that the death rate

TABLE 3B<sup>a</sup>

Model and reference	Magnesium salts	Parameter
Guinea pigs Lamarche et al. (31)	Mg + K aspartate, iv (alone and in combination)	Protection against ECG changes and against tachycardia
Lamarche et al. (33)	Mg or KCl	Not effective
Guinea pigs Hochrein and Lossnitzer (34)	Mg + K aspartate	Doubles cardiac tolerance of asphyxia (cardiac respiration)
	K aspartate	No protection
	Mg aspartate	Some protection (less than with combination)
	Mg + K aspartate	Decreases loss of myocardial K

<sup>a</sup> In vivo hypoxia; asphyxia.

TABLE 3C<sup>a</sup>

Model and reference	Magnesium salts	Parameter
Rats } Trzebski and Rabbits } Lewartowski (36)	Mg + K aspartate } Mg + K chloride }	Increased coronary flow (of perfusion fluid)
	Mg + K aspartate (but not chloride)	Increased resistance to anoxia: 1. 3-7 times less reduction of systolic amplitude 2. Protection against ECG changes 3. Increased worktime
Guinea pigs Lamarche and Royer (31) Lamarche and Tapin (32, 33)	Mg + K aspartate (D-aspartate not L-aspartate)	Negligible effect on coronary flow  Protection against anoxia: 1. Protection against ECG changes 2. 35% prolongation of time to produce 75% reduction of systolic amplitude
Guinea pigs Rosen et al. (35)	Mg + K aspartate (1.0 mg/ml of Chenoweth solution) more effective than Mg + KCl at equivalent concentration  Mg + KCl  Mg + K aspartate	Increased resistance to anoxia (increased time for amplitude of heart beat to decrease to 50% control)  Coronary flow increased over perfused nonanoxic heart  Coronary flow increased in both nonanoxic and anoxic hearts

<sup>a</sup> In vitro hypoxia; anoxia (isolated heart).

from apoplexy in Japan was higher in soft water areas than where the water was hard. Schroeder (41-45) then correlated the death rates from hypertensive and arteriosclerotic heart disease in the states with the average hardness of drinking water<sup>3</sup> and found an inverse correlation. This was particularly notable for white men of 45 to 64 years of age as regards coronary heart disease death rates. The scatter graph (Fig. 2) shows that, with few exceptions, the states with the hardest drinking water had lower, and the states with the softest water had higher than average, death rates from ischemic heart disease. Further analysis of the states with the hardest and softest water reveals the markedly greater susceptibility to fatal heart attacks of white men aged 45 to 64, as compared with the total (age adjusted) male population (Fig. 3).

It is possible that this substantial difference may be caused by a racial difference in susceptibility to this disease. This is suggested by the figures from such southern states as

Alabama and South Carolina where the white male versus total male coronary death rates are 433:176 and 619:217/100,000, respectively, and where the nonwhite population contributing to the total figures is predominantly black. Phillips and Burch (46) analyzed the literature in which the racial incidence of ischemic heart disease was given and evaluated their own data; they also found a significantly greater incidence of ischemic heart disease among white than black men. Bersohn (47) and Bersohn and Oelofse (48) also commented on the much greater susceptibility to ischemic heart disease of the African whites than the blacks and considered the higher serum Mg of the blacks a possibly significant factor.

Figure 3 also demonstrates that the more highly industrialized and more densely populated states tend to have higher coronary death

<sup>3</sup> Average hardness figures hide major differences in hardness of water in different areas, particularly in large states.

states than do the rural states. Comparison of death rates in three cities with hard, average, and soft water, illustrates strikingly the influence of the "water protective factor" in the high risk group (Fig. 4).

There has since been corroboration that the incidence of ischemic heart disease is higher in soft than in hard water areas (49-61). Calcium and magnesium have been considered as possibly protective factors, with both contributing to the hardness of the water. As calcium is usually present in larger amounts than is

magnesium, there has been more attention paid to the possibility that it is calcium that is the protective "water factor" (50, 51, 53, 55, 58, 59). Those who have had favorable experience in the treatment of ischemic heart disease with magnesium salts consider the hard water protective factor more likely to be magnesium than calcium (62-64), a position also taken by the present authors and demonstrated graphically (Fig. 5 (64a, 64b)) by Marier (65). Allen (49) has recently completed an exhaustive correlation of age and sex-specific death rates in municipalities in Ontario by total water hardness and by the calcium and magnesium components. His mathematical computation suggest that the protective effect of hard water is due to the magnesium component. In terms of percentage variation in death rates, he found that magnesium was more effective than total hardness, which in turn was more effective than calcium in favorably influencing the rate of sudden deaths from ischemic heart disease (Fig. 6). Allen's (49) decision to separate coroner-certified coronary deaths from total cardiovascular deaths, which revealed magnesium to be the most significant factor, was based on the observations of Crawford and Crawford (54) and of Anderson et al. (50). These investigators (50, 54) had observed that the incidence of sudden death from ischemic heart disease is notably higher in soft than in hard water areas.

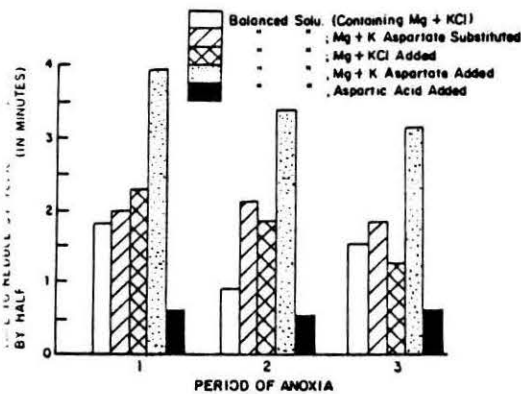

FIG. 1. Protection against anoxia by magnesium and potassium aspartate solution (isolated guinea pig heart in Chenoweth (modified Locke-Ringer solution; J. Lab. Clin. Med. 31: 600, 1946)). Adapted from (35).

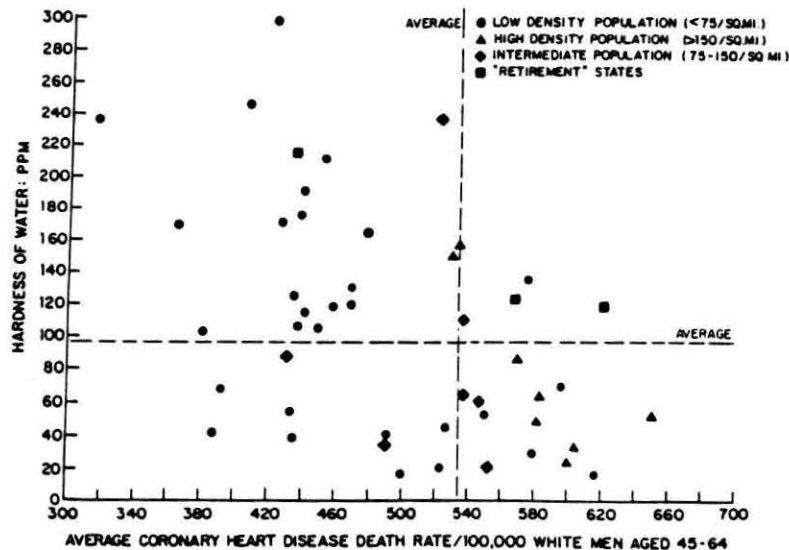

FIG. 2. Correlation of coronary heart disease death rates (1950) of white men 45 to 64 years of age with hardness of water by states in the United States. Adapted from (41).

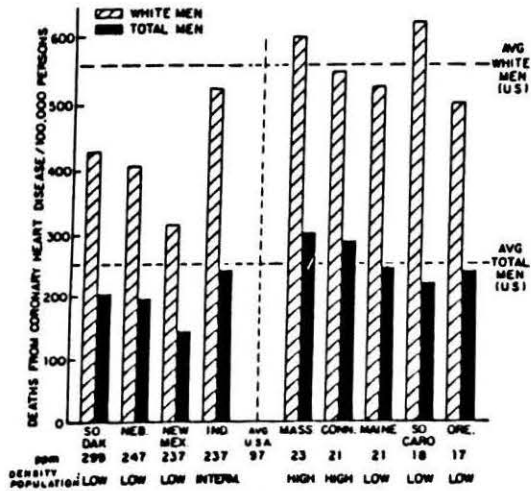

FIG. 3. Deaths from ischemic heart disease of white men aged 45 to 64 years versus total population of men (age-corrected) by states and with hard versus soft water. Adapted from (41).

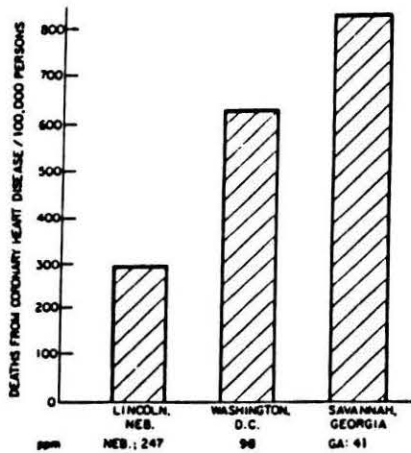

FIG. 4. Deaths from ischemic heart disease of white men aged 45 to 64 years in cities with hardest, average, and softest water. Adapted from (41).

The rates of sudden coronary deaths were derived from coroner-certified death reports in Ontario by Anderson et al. (50) as likely to have been caused by rapidly fatal arrhythmias. Peterson et al. (57) confirmed these findings in the state of Washington. Neri et al. (66), however, evaluated the data from Ontario differently. Allen (49) has resolved the conflict in interpretations by pointing out that Neri et al. (66) had examined only the percentage of cardiovascular deaths that were coroner-certified, rather than the actual death rates. His own

extensive study clearly confirmed the conclusions of Anderson et al. (50).

Anderson and his associates (50) suggested that there is something in hard water that specifically protects against fatal cardiac arrhythmia arising shortly after a myocardial infarction. Bajusz (67) had earlier called attention to the possibility that it might be the magnesium in hard water that protects the myocardial cell against the insult caused by ischemia, as well as improving its ability to resist potentially cardiotoxic agents. When he first noted the relationship between water hardness and cardiovascular mortality, Schroeder (43, 44) pointed out that in cities with higher and lower coronary heart disease death rates for 45- to 64-year-old white men, the

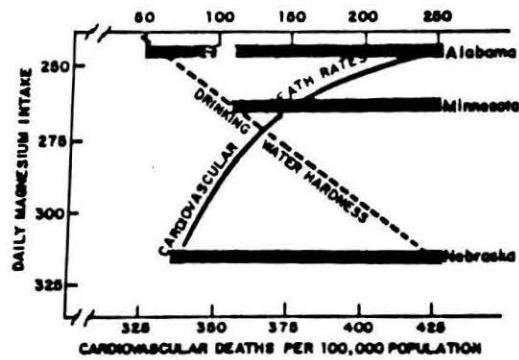

FIG. 5. Correlation of cardiovascular deaths with total hardness of water and daily intake of magnesium. Data on total hardness of drinking water from (64a and 64b). Adapted from (65).

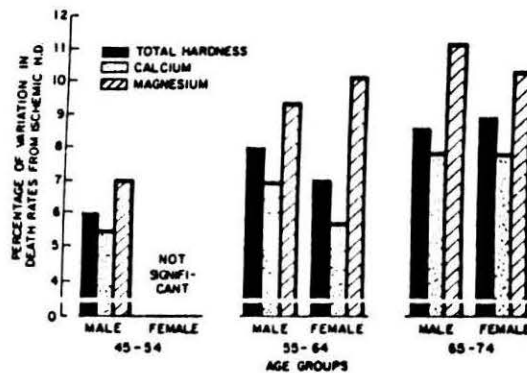

FIG. 6. Percentage of the total variations in death rates (coroner-certified deaths from coronary heart disease) from ischemic heart disease as influenced by water hardness, the calcium component, and the magnesium component; highly significant variations. Adapted from H. A. J. Allen doctoral dissertation, 1972 (49).

magnesium content of the water was 4:16, respectively. He and his co-workers (68) later concluded, on the basis of their own extensive analyses as well as from indirect evidence (69), that a good argument could be made for the existence of magnesium deficiency in the United States. They accepted as likely that diets high in calories and low in magnesium are atherogenic. They questioned, however, whether the amount of magnesium provided by hard water is sufficient to serve as the only protective factor against deaths from cardiovascular disease. Goldsmith (70) and Hankin and Goldsmith and Margen (71) have calculated that 12% of the daily Mg intake is derived from water. Among those using hard water only, as much as 18% of the Mg intake was from water (70), an amount that may well be critical.

The findings of Crawford and Crawford (54) that men under 40, who were living in a soft water area and who had died in accidents, had lower coronary magnesium levels and greater evidence of prior myocardial disease than did comparable men from a hard water area (Fig. 7) support the contention that lower magnesium levels are related to clinical ischemic heart disease. The higher coronary magnesium levels in the older age groups were postulated by the authors to have been caused by deposition of mineral deposits (Mg as well as Ca) in established coronary lesions. That life-long exposure to soft water is not necessary for higher death rates to be manifest is indicated by the evidence that softening previously hard water resulted in significantly elevated death rates from cardiovascular diseases from those in the community before the hard drinking water had been softened (52, 58, 59).

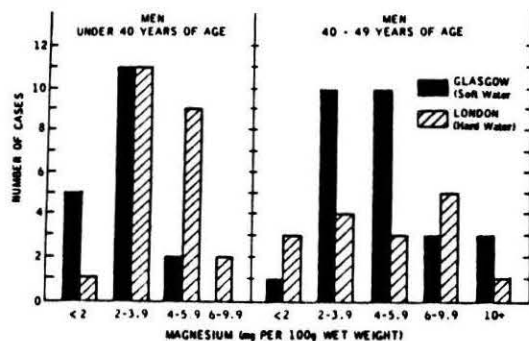

FIG. 7. Coronary magnesium in accident cases of men under 60 years of age in Glasgow and London. Reprinted with permission of the publisher (54).

TABLE 4  
Magnesium deficiency sensitizes to cardiopathic diets, drugs, stress

Diets	
Atherogenic diet	{ Saturated fat; } { Vitamin D <sub>2</sub> Thiouracil Calcium load
Infarctoid diet	{ Saturated fat, cholesterol High protein Vitamins D <sub>2</sub> , D <sub>3</sub> High in Ca, Na, PO <sub>4</sub> Low in Mg, K, Cl
Stress: isolation	
Genetic susceptibility: cardiomyopathy	
Drugs	
Mineralocorticoid + PO <sub>4</sub>	
Vitamin D <sub>2</sub> ; dihydrotachysterol	
Digitalis (arrhythmia)	
Epinephrine; isoproterenol	

#### Magnesium, not calcium, as protective factor

The question as to what it is in hard water that affords protection against both the development of coronary arteriosclerosis and the sudden death following an infarction is still controversial. The only definitive experimental study of the effect of calcium and magnesium in drinking water (on development of arteriosclerosis) is that reported by Neal and Neal (72). They found that rabbits on atherogenic diets that were given hard water to drink had less arterial damage than did those given distilled water. Addition to the distilled water of magnesium but not calcium completely protected against arteriosclerosis.<sup>4</sup>

The preponderance of direct and indirect evidence also favors magnesium as the myocardial protective factor. Firstly, magnesium deficit is known to cause functional and structural cardiovascular damage, including early mitochondrial and sarcosomal damage (73-78) and frank myocardial necrosis and calcification (75, 76, 79-98). Secondly, Mg deficiency sensitizes animals to myocardial necrosis produced in a number of laboratory models (Table 4), including those of dietary imbalances, stress, and drugs (85, 87-89), and accelerates the development of cardiac necrosis in hamsters genetically predisposed to cardiomyopathy (98). Furthermore, magnesium deficiency increases suscepti-

<sup>4</sup> *Infra vide* for further discussion of magnesium, atherogenic diets and serum lipids.



bility to digitalis toxicity (23, 99–104), as hypomagnesemia has been reported in patients with digitalis toxicity (99, 100, 105), and magnesium is useful in counteracting digitalis-induced arrhythmias (100, 102, 106–110) and has protected against the cardiac necroses of the above experimental models (85, 86, 90, 96, 98, 111–121).

Calcium administration, in contrast, intensifies acute and chronic manifestations of Mg deficiency (122–128) and increases the cardiovascular damage caused by atherogenic- and infarction-producing diets (120–126, 128–133) or by cardiotoxic agents (85, 90, 96, 134). Lehr and Krukowski (114, 135) have postulated that hypercalcemia-inducing agents may exert their damaging effects on the cardiovascular system via induction or intensification of magnesium deficiency. Excess of adrenergic catecholamines may cause cardiac necrosis because they induce an adverse Ca/Mg ratio within the myocardium. Lehr et al. (134, 136, 137) demonstrated that these drugs cause an elevation in myocardial Ca and a drop in myocardial Mg within 3 hr that is maximal by 24 hr (Table 5). They considered this early electrolyte shift to play a contributory role in the initiation of dysfunction and morphologic alterations, and suggested that administration of MgCl<sub>2</sub> might correct the cellular depletion, thereby protecting against catecholamine injury. Fleckenstein et al. (113, 138, 139) have demonstrated that large doses of catecholamines cause not only an excessive Ca influx but also a dangerous fall in high-energy phosphate content of heart muscle prior to development of necrosis. Ca-antagonistic compounds and MgCl<sub>2</sub> protect against the excessive Ca-

uptake and greatly diminish the structural damage (138, 140).

The thesis of Covino and Hegnauer (141) further negates calcium as a protective factor. They suggested that small increases in intracellular Ca<sup>2+</sup> are associated with augmentation of cellular excitability, thereby contributing to the development of ventricular arrhythmia. Commenting on this postulate, Cummings (3) observed that the slightly reduced plasma Ca<sup>2+</sup> at the time the plasma Mg<sup>2+</sup> was sharply elevated (after coronary ligation) may have been caused by a shift of Ca from plasma to myocardium. That such an early elevation of myocardial Ca does, in fact, take place as myocardial Mg drops has been demonstrated both in experimental models of myocardial infarction and in human victims (1, 2).

Dietzman et al. (142) demonstrated that a continuous infusion of CaCl<sub>2</sub> to dogs caused myocardial hyperexcitability with an increased propensity toward appearance of ventricular ectopic beats. Fukuda (143) has demonstrated that Ca excess in Ringer's solution resulted in multiple firing of the frog's ventricle in response to a single stimulus. The more physiologic studies of Haddy and Scott et al. (39, 144–146) have shown that only slight changes in plasma Ca/Mg concentrations affect coronary resistance, relative hypercalcemia causing coronary constriction (particularly in the presence of hypomagnesemia), and relative hypermagnesemia causing coronary vasodilation (Fig. 8).

*Use of magnesium in treatment of cardiac ischemia.* Zwilling (110) first reported in 1935 the efficacy of intravenous MgSO<sub>4</sub> in counteracting cardiac arrhythmia of digitalis toxicity. Having demonstrated that MgSO<sub>4</sub> has

TABLE 5  
Calcium/magnesium myocardial shift by cardiac necrosis-inducing doses of adrenergic catecholamines<sup>a</sup>

Injection	Heart electrolytes, mg/kg							
	Calcium				Magnesium			
	Hours after injection							
	Control	3	6-7	24	Control	3	6-7	24
Isoproterenol	2.8	3.8	4.8	4.3	19.2	17.0	16.3	15.6
Phenylephrine	1.7	2.5	3.3	10.4	19.9	18.7	17.8	17.3
Epinephrine	1.7	2.1	4.5	9.1	19.9	18.7	18.5	16.5

<sup>a</sup> Adapted from Lehr et al. (134, 136, 137).

a coronary vasodilator effect. Elek and Katz (147) recommended its use in 1942 in paroxysmal tachycardias associated with myocardial ischemia. They commented that this use would be particularly appropriate because Mg diminishes cardiac ischemia, which itself tends to establish and maintain ectopic rhythms. Referring to the use of iv  $MgCl_2$  by Seekles et al. in 1930 (148) to prevent cardiac arrhythmias evoked by  $CaCl_2$  (treatment of cows with milk fever or grass staggers, which was shown soon after to be a Mg-deficiency syndrome (83, 149)). Boyd and Scherf (150) confirmed the efficacy of  $MgSO_4$  therapy of paroxysmal tachycardia. Szekely (151) pointed out that patients whose arrhythmias responded best to magnesium usually had advanced heart disease with congestive heart failure. Nonetheless, the use of magnesium in ischemic heart disease has been slow to gain acceptance, particularly in North America. Favorable results have been reported from the Southern Hemisphere (64, 152-161), from both Eastern (121, 162, 163) and Western Europe (23, 31, 106, 164-177), and in Great Britain (19, 63, 178-183). The reports have been predominantly based on noncontrolled clinical trials of the use of several magnesium preparations, sometimes in association with other agents such as heparin (154, 159) and hyaluronidase (177) that complicate interpretation of results.

The first such report (in 1952) was that of Hoffman and Siegel from Germany (184), who reported excellent results in terms of reduced incidence of anginal attacks during treatment of their coronary angina patients with an oral preparation of magnesium nicotinate and thio-sulfate. Malkiel-Shapiro (154) and he and his

co-workers (155, 156) have reported remarkably good results with  $MgSO_4$  in the treatment of patients during an acute attack of coronary thrombosis. They reported a low death rate of 1 in 64 in their patients with myocardial infarcts so treated. For acute myocardial infarction, in addition to the usual supportive therapy, they generally inject  $MgSO_4$  iv or im (0.5 ml of 50% solution) immediately, 12 to 24 hr later, and then 1 ml im the next day and every 2 to 5 days thereafter until discharge. They maintain patients convalescing from an infarct and those with chronic angina pectoris by injecting either 0.5 ml of the  $MgSO_4$  im solution at 7-day intervals over an indefinite period or larger doses, given more frequently in intermittent courses (154). Parsons et al. (159) reported only 1 death in 33 cases of infarction. Perlia (162), in 1956, and more recently Savenkov and associates (163) also reported striking subjective improvement in over 90% and 79% of their coronary patients in response to iv  $MgSO_4$  (162) or to parenteral and oral use of magnesium adipinate and nicotinate (163).

The use of magnesium and potassium aspartate, other organic salt, or chloride alone, or as part of a "polarizing solution" (containing glucose and insulin) has been reported by many German and French investigators to have improved significantly the chances of survival of victims of acute myocardial infarction (10, 165, 168-174). Prompt iv administration of Mg and K aspartate solution repeated daily (in doses as high as 4 to 5 g/day during the 1st week of hospitalization, with substitution thereafter of oral treatment) has been reported by Nieper and Blumberger (172) to have relieved postinfarction pain and to have markedly improved the rate of survival. Also reported is the long-term efficacy of oral Na and K aspartates in patients with chronic ischemic heart disease, either after an acute infarction or in patients with histories of coronary insufficiency (164, 170-173). Ionophoretic use of  $Mg^{2+}$  and  $K^+$  has also been described as helpful in the treatment of cardiac ischemia (166, 167). Thurnherr and Koch (177) reported that 90% of 156 patients with coronary insufficiency responded both subjectively (pain) and objectively (exercise tolerance) to injection with a combination of magnesium levulinate and hyaluronidase. The study was controlled and injections of physiological saline served as the placebo.

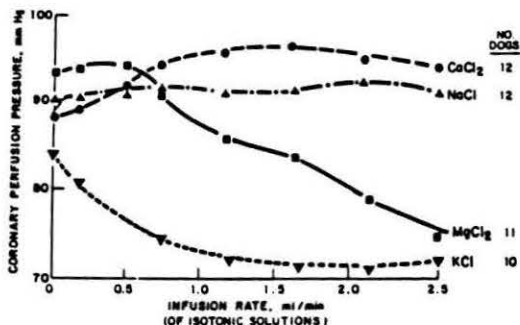

FIG. 8. Influence of  $Mg^{2+}$ ,  $K^+$ ,  $Na^+$  and  $Ca^{2+}$  on coronary resistance of in situ dog hearts at blood flow rates of 96 to 100 ml/min. Adapted from (39).

*Mechanisms of magnesium effects in ischemic heart disease.*

**Blood lipids.** A commonly cited explanation for the clinical efficacy of magnesium relates to its effect on the blood. Clinicians from the British Commonwealth (64, 154-158, 161) and Russia (163) have reported that magnesium therapy of patients with ischemic heart disease is associated with decreased  $\beta$ -lipoproteins, increased  $\alpha$ -lipoproteins, and increased lecithin/cholesterol ratio, or a drop in serum chole-

sterol. There has not been agreement, however, that magnesium deficiency (as expressed by low plasma Mg levels) is necessarily correlated with lipemia in cardiovascular disease patients (21, 22, 185-187). Some insight into discrepancies in clinical results can be obtained from animal studies (Tables 6, 7). Depending on the nature of the fat given and the degree of the Mg deficiency, the serum cholesterol rose, was unchanged, or showed an increase in esterification (103, 122, 132, 188). Correction of the magnesium deficit has protected against cardio-

**TABLE 6**  
Effect of high and low saturated and unsaturated fat intakes and of magnesium on serum lipids in rats<sup>a</sup>

Dietary fat <sup>b</sup>	Serum magnesium, mg/100 ml		Serum cholesterol, mg/100 ml		Serum lipoproteins			
	Saturated	Unsaturated	Saturated	Unsaturated	Alpha		Beta	
					Saturated	Unsaturated	Saturated	Unsaturated
Low fat intake, 5%								
Low magnesium	1.08	1.25	105	127	9.7	6.9	11.7	8.8
Moderate magnesium	2.21	2.03	99	138	8.5	10.0	10.3	10.6
High magnesium	2.56	1.91	83	116	4.1	7.3	4.8	7.7
High fat intake, 20%								
Low magnesium	1.51	0.96	115	115	15.9	8.1	11.8	8.5
Moderate magnesium	1.89	1.99	113	123	16.3	6.9	12.6	5.4
High magnesium	2.09	1.95	97	102	7.7	4.0	6.3	4.8

<sup>a</sup> Adapted from (189). Low magnesium = 24 mg/100 ml; moderate magnesium = 96 mg/100 ml; high magnesium = 192 mg/100 ml.

<sup>b</sup> Dietary fat: saturated: hydrogenated cottonseed oil; unsaturated: corn oil.

**TABLE 7**  
Lipids in experimental magnesium deficiency in dogs

Mg intake	Fat intake		Reference
0.08% of diet	Butter fat (8% of diet)	↑ Percent esterified cholesterol ↓ Fatty acids No change in total serum lipids	Kruse et al. (188)
0	Corn oil (9% of diet)	No change in blood cholesterol	Vitale et al. (103)
90 ppm 180 ppm	Animal fat (20% of diet)	{ Aortic lesions ↑ Serum cholesterol No aortic lesions ↑ Serum cholesterol	Bunce et al. (122)
0 (Also free of K, high in vitamin D; Ca, PO <sub>4</sub> , protein)	Animal fat	Cardiopathogenic ↑ Serum cholesterol	Sos et al. (131-133)

vascular lesions of several species of animals on atherogenic Mg-deficient diets without a consistent effect on serum lipids (72, 104, 122, 128, 189–193). Except for a series of studies that showed Mg supplementation to lower serum cholesterol of milk-fed rats (194–196), and another that showed no effect on either cardiovascular or serum lipids of rabbits on atherogenic diets (197), administration of magnesium changed the distribution of lipid components somewhat or even raised the levels (72, 104, 128, 189, 193). Nakamura et al. (190) found that for a notable effect on aortic deposition of lipids and serum lipids, substantial and long-term Mg supplementation is necessary.

*Fibrinolysis/coagulation.* The efficacy of magnesium in ischemic heart disease has been attributed to its antithrombotic activity, both enhancement of fibrinolysis and inhibition of coagulation being considered as mediating mechanisms. Substantially increased fibrinolytic activity of the blood of cardiac ischemia patients on Mg therapy has been reported by Parsons et al. (159, 160). This observation recalls the explanation of the efficacy of the earlier use of Mg in prevention of postoperative thrombosis (198, 199) and in treatment of peripheral thrombotic disease (200, 201). The antithrombotic effect of magnesium has also been attributed to stabilization of platelet membranes (200, 202) and to inhibition of platelet aggregation (19, 183, 203, 204). Supportive of the platelet membrane theory is recent work that has shown that Mg is necessary to maintain the disc shape of platelets (205). Addition of  $MgCl_2$  to fresh human blood, under conditions that maintained electrolytes and enzyme systems as nearly normal as possible, resulted in reduction in the size and number of platelet clumps and an increase in the number of discrete platelets (183). Hughes and Tonk's (19) observations that rabbits with intravascular coagulation (induced by mineralocorticoid and monobasic sodium phosphate) have a 40% reduction of plasma Mg suggested to them that the subnormal Mg plasma levels of their patients with myocardial infarcts might be causally related to their enhanced platelet aggregation. Durlach's (203) Mg-deficient patient with hypercoagulability of the blood and phlebothrombosis, who improved on oral administration of large doses of Mg (Mg lactate,

4.5 g/day) further demonstrates the interrelation between depression of Mg and increased tendency toward thrombosis. That the estrogen-induced hypercoagulability of the blood may also be mediated in part by decreased serum Mg has been suggested by Goldsmith et al. (25, 206–209). They have shown that estrogen oral contraceptives lower serum magnesium levels both in women (206, 207, 209) and in rats (25, 206, 208).

The antagonism of magnesium for calcium for clotting factors (210), even at concentrations produced after oral administration (182), has been considered another explanation of its anticoagulant activity (178, 182, 210, 211). A single oral dose has produced a delay in thrombin generation, lasting for up to 6 hr, in patients with ischemic heart disease (178, 182).

Stevenson and Yoder (212) have recently shown that Mg deficiency in calves and rats caused shortened partial thromboplastin time and thrombin clotting time but no significant changes in platelet aggregation or prothrombin time. Szelenyi et al. (213, 214) demonstrated that the hypercoagulability of blood, elicited in rats by atherogenic diets rich in animal fats and vitamin  $D_2$ , could be repressed by oral or intravenous administration of  $MgCl_2$  in acute and long-term experiments. Five times the normal magnesium requirements, added to this diet, prevented the accelerated clotting of blood seen in animals that were given the fatty diet but with less magnesium. The magnesium supplementation normalized the coagulation time and prothrombin consumption times in both rats (Fig. 9) and dogs (Fig. 10) on the high fat diets. These investigators suggest that magnesium influences thrombosis: 1) by interfering with intravascular coagulation through its competition with calcium and by stabilizing fibrinogen and the platelets, 2) by promoting fibrinolysis, and 3) by causing vasodilatation.

A modification of this diet (poor also in Mg, K, and Cl) has been used by Sos and Rigo et al. (118, 120, 130–132) to produce myocardial infarction in several animal species. High Mg intake prevented the cardiac lesions (118–121, 133).

High intakes of vitamin  $D_2$  (215–219) or fat (189, 193, 220–223) have been shown to increase magnesium requirements markedly and to intensify damage caused by magnesium deficiency, a possible explanation of the high

usage of magnesium required for favorable effects in the above study (213). That this observation has clinical relevance is suggested by the tendency of people in the Occident to consume too much fat and by the evidence that vitamin D<sub>2</sub> intake, too, may be excessive in some of those who drink fortified milk (224-6), whereas the Occidental diet tends to be low in magnesium (68, 69). This combination of dietary imbalances may produce sufficient magnesium deficiency to contribute to the cardiovascular disease problems of the Western world (1, 2, 69, 227, 228).

*Magnesium and myocardial metabolism*

Magnesium has a pivotal position in normal physiology, participating in many enzyme sys-

tems. The evidence as to its importance in maintaining mitochondrial integrity and in retaining myocardial potassium has been considered elsewhere (1). Magnesium is involved in normal mitochondrial contraction with formation of the compact Mg-ATP complex and is involved in the electron transport system (Fig. 11). With depletion of cardiac magnesium, whether from ischemia or cardiotoxic drugs, mitochondrial swelling progresses to disorganization and disruption (Fig. 12).

The importance of magnesium and potassium in myocardial aerobic metabolism has been stressed by Laborit (168), who studied the effects of the aspartates of these cations in experimental cardiac anoxia (supra vide), and by Nieper and Blumberger (172) who introduced the use of the substances in the clinic. The latter investigators consider the intracellular metabolic effects of magnesium far more

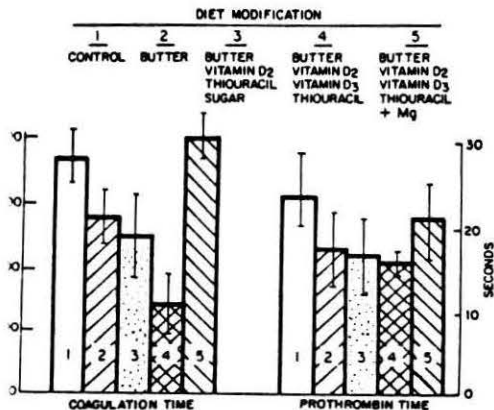

FIG. 9. Effect of magnesium on coagulation times of rats on thrombogenic, cardiopathic diets. Adapted from (213, 214).

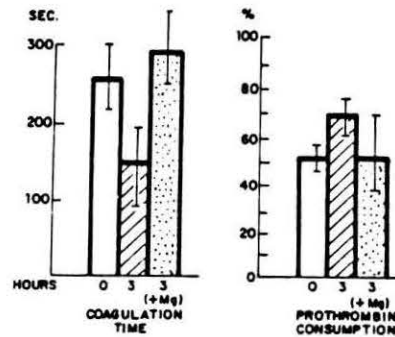

FIG. 10. Effect on canine clotting functions of acute butter load with and without intravenous magnesium. Adapted from (213).

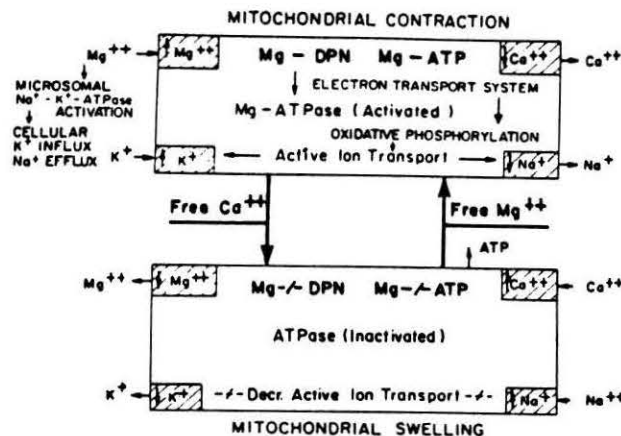

FIG. 11. Physiologic mitochondrial processes. From (1).

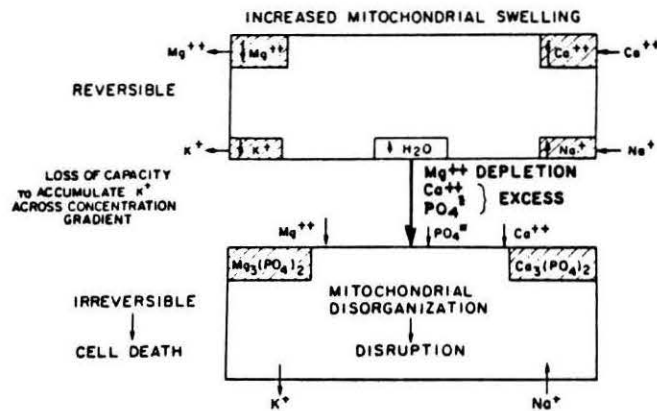

FIG. 12. Mitochondrial changes with magnesium deficiency. From (1).

important in the treatment of cardiac ischemia than its antithrombotic effects. They have pointed out that Parsons et al. (160), who stressed the importance of the activation of fibrinolysis by magnesium, commented on the striking improvement in mortality rates of patients with infarctions on  $MgSO_4$  as compared with the one-third fatality rate when routine anticoagulant therapy was used (the year before institution of the magnesium therapeutic regimen). Nieper and Blumberger (172) recommend use of the magnesium and potassium aspartates on the grounds that better penetration by Mg and K of the cell membrane may thereby be provided. They have reported that such treatment has corrected the abnormal oxidative metabolism of the ischemic or digitalis-treated heart, as measured by an increase to a more normal pyruvic acid/lactic acid ratio and by elevation of  $\alpha$ -ketoglutaric acid (an indicator of activation of the tricarboxylic acid cycle). Simon (175) considers all of the cited mechanisms to be operative in the favorable effects of Mg in the treatment of myocardial infarction, a judgment in which the present authors concur.

#### Concluding comments

The usefulness of magnesium in ischemic heart disease is probably best explained by its metabolic effects at the cellular level, but its interrelations with lipid metabolism and coagulation-fibrinolytic mechanisms are probably also significant. It 1) counteracts the adverse effects of excessive intracellular calcium, 2) plays an important role in retaining intracellular

potassium, and 3) is important in maintaining the integrity of the subcellular structures. Its role in maintaining normal rhythmicity of the heart in the face of an ischemic insult may well explain the difference in sudden cardiac death rates in hard and soft water areas. Therapeutic use of magnesium in acute ischemic heart disease may well be justified. The long-term prophylactic use of magnesium for the inhibition of atherogenesis or the prevention of acute ischemic attack, or both, requires further study.

#### References

1. SEELIG, M. S. Myocardial loss of functional magnesium. Part I. Effect on mitochondria integrity and potassium retention. In: *Myocardiology*, edited by E. Bajusz and G. Rona. Baltimore: University Park, 1972, vol. 1, p. 615.
2. SEELIG, M. S. Myocardial loss of functional magnesium. Part II. Cardiomyopathies of diverse etiology. *Myocardiology*, edited by E. Bajusz and G. Rona. Baltimore: University Park, 1972, vol. 1, p. 626.
3. CUMMINGS, J. R. Electrolyte changes in heart tissue and coronary arterial and venous plasma following coronary occlusion. *Circulation Res.* 8: 865, 1960.
4. CUMMINGS, J. R., AND B. B. CLARK. Electrolyte studies on coronary dog preparations. *Pharmacol. Exptl. Therap.* 389, 1957 (abstr. 1239).
5. RIGO, J., T. GATT, E. POSCH AND I. SZELENYI. Die infolge der Ligatur eines Astes der A. coronaria zustandekommend Electrolyt veränderungen in Myokard. *Vitalstoffe Zivilisationskrankh.* 11: 181, 1966.
6. JENNINGS, R. B. Symposium on the pre-hospital phase of acute myocardial infarction, Part II—Early Phase of Myocardial Ischemic

- Injury and Infarction. *Am. J. Cardiol.* 24: 753, 1969.
7. JENNINGS, R. B., AND A. C. SHEN. Calcium in experimental myocardial ischemia. In: *Myocardiology*, edited by E. Bajusz and G. Rona. Baltimore: Univ. Park Press, 1972, vol. 1, p. 639.
  8. HOCHREIN, H., H. J. KUSCHKE, Q. ZAQQA AND E. FAHL. Das Verhalten der Intracellularen magnesium-konzentration in myocard bei Insuffizienz, Hypoxie und Kammerflimmern. *Klin. Wochschr.* 45: 1093, 1967.
  9. CANEPA, J. R., AND O. A. GOMEZ-POVINA. Electrolyte changes in the ventricular myocardium following experimental hemorrhagic hypotension in the dog. *Surg. Res.* 3: 335, 1965.
  10. ISERI, L. T., L. C. ALEXANDER, R. S. MCCAUGHEY, A. J. BOYLE AND G. B. MYERS. Water and electrolyte content of cardiac and skeletal muscle in heart failure and myocardial infarction. *Am. Heart J.* 41: 215, 1952.
  11. MEISTER, H., AND H. J. SCHUMANN. Untersuchungen über den Calcium und Magnesiumgehalt und Leichenberzen bei Herzinsuffizienz und Myocardinfarkt. *Beitr. Pathol. Anat.* 126: 486, 1962.
  12. RAAB, W. Myocardial electrolyte derangement: crucial feature of pluricausal so-called coronary heart disease. *Ann. N.Y. Acad. Sci.* 147: 627, 1969.
  13. RAAB, W. Cardiotoxic effects of emotional, socioeconomic and environmental stresses. In: *Myocardiology*, edited by E. Bajusz and G. Rona. Baltimore: University Park, 1972, vol. 1, p. 707.
  14. HEGGTVEIT, H. A., P. TANSER AND B. HUNT. Magnesium content of normal and ischemic human hearts. 7th Intern. Congr. of Clinical Pathology, Montreal, July 13-19, 1969, p. 53.
  15. LAURENDEAU, E., AND J. P. DURUISSEAU. Electrolytes in aging human and animal normal and pathological heart. *Memorias LV Congress Mundial De Cardiologia* 5: 245, 1963.
  16. DURUISSEAU, J. P. Magnesium sérique et tissulaire. First Intern. Symp. on Magnesium Deficit in Human Pathology, edited by J. Durlach. Paris: Vittel, 1971. Vol. Communications: 357, 1973.
  17. SINGH, C. H., C. T. G. FLEAR, A. NANDRA AND D. N. ROSS. Electrolyte changes in the human myocardium. *Cardiology* 56: 128, 1971-1972.
  18. HOLTMEIER, H. J. Magnesiumstoffwechselsstoy und Herzinfarkt. In: *Herzinfarkt und Schoch*, edited by L. Heilmeyer and H. J. Holtmeier. Stuttgart: George Thieme Verlag, 1969, p. 110.
  19. HUGHES, A., AND R. S. TONKS. Platelets, magnesium and myocardial infarction. *Lancet* 1: 1044, 1965.
  20. NATH, K., K. K. SIKKA, B. K. SUR, C. P. SAXENA AND S. SRIVASTAVA. Serum magnesium in clinical and experimental myocardial infarction. *Indian J. Med. Res.* 57: 317, 1969.
  21. BROWN, D. F., R. B. MCGANDY, E. GILLIE AND J. F. DOYLE. Magnesium-lipid relations in health and in patients with myocardial infarction. *Lancet* 2: 933, 1958.
  22. HYATT, K. H., L. LEVY, M. NICHAMAN AND M. OSCHWITZ. Relationship of serum magnesium levels to serum cholesterol and triglyceride levels and to myocardial infarction. *Appl. Spectroscopy* 20: 142, 1966.
  23. LOSSNITZER, K. Cardiological aspects of hypo- and hypermagnesemia. *Klin. Wochschr.* 49: 1153, 1971.
  24. CLARK, B. B., J. R. CUMMINGS AND E. SMITH. The influence of electrolyte changes on the effects of antiarrhythmic drugs: some preliminary observations. *J. New Engl. Cardiovascular Soc.* 14: 27, 1956.
  25. GOLDSMITH, N. F., H. HUGGEL AND H. K. URY. Serum electrolytes and clotting factors in rats during blood loss by cardiac puncture: effect of norethynodrel with mestranol on serum magnesium. *Rev. Suisse Zool.* 76: 849, 1969.
  26. HARRIS, A. S., A. ESTANDIA, H. SMITH, R. W. OLSEN, T. J. FORD, JR. AND R. F. TILLOTSON. Magnesium sulfate and chloride in suppression of ectopic ventricular tachycardia accompanying acute myocardial infarction. *Am. J. Physiol.* 172: 251, 1953.
  27. CLARK, B. B., AND J. R. CUMMINGS. Arrhythmias following experimental coronary occlusion and their response to drugs. *Ann. N.Y. Acad. Sci.* 64: 543, 1956.
  28. CARDEN, N. L., AND J. R. STEINHAUS. Role of magnesium ion in the initiation of ventricular fibrillation produced by acute coronary occlusion. *Circulation Res.* 5: 405, 1957.
  29. BAJUSZ, E., AND H. SELYE. The chemical prevention of cardiac necroses following occlusion of coronary vessels. *Can. Med. Assoc. J.* 82: 212, 1960.
  30. WEBER, B., H. LABORIT, J. M. JOUANY, P. NIAUSSAT AND C. BARON. Modifications des signes electrocardiographiques de l'infarctus du myocarde experimental chez le lapin per l'injection de deis de l'acide aspartique. *Compt. Rend. Soc. Biol.* 152 (Part 1): 431, 1958.
  31. LAMARCHE, M., AND R. ROYER. Aspartic acid salts and the cardiovascular diseases. In: *Electrolytes and Cardiovascular Diseases*, edited by E. Bajusz. Basel: S. Karger, 1965, vol. 1, p. 104.
  32. LAMARCHE, M., AND M. TAPIN. Action d'un melange de sels de l'acide aspartique sur le coeur isole de cobaye. *Compt. Rend. Soc. Biol.* 155 (Part 1): 377, 1961.
  33. LAMARCHE, M., M. TAPIN AND R. ROYER. Activite pharmacodynamique cardiaque des aspartates. *Therapie* 17: 935, 1962.
  34. HOCHREIN, H. A., AND K. LOSSNITZER. The interrelation between myocardial metabolism and heart failure. *Ann. N. Y. Acad. Sci.* 156: 387, 1969.
  35. ROSEN, H., J. McCALLUM, A. BLUMENTHAL AND H. P. K. AGERSBORG. Effects of potassium and magnesium aspartates on the isolated guinea pig heart. *Arch. Intern. Pharma-*

- codyn. 147: 476, 1964.
36. TRZEBSKI, A., AND B. LEWARTOWSKI. Increased anoxia resistance of the heart perfused with aspartic acid salts. *Bull. Acad. Pol. Sci.* 7: 283, 1959.
  37. BASS, P., I. MAXURKIEWICZ AND K. I. MELVILLE. Effects of magnesium on coronary flow and heart action and its influence on the responses to adrenaline and noradrenaline. *Arch. Intern. Pharmacodyn.* 117: 9, 1958.
  38. SMITH, P. K., A. W. WINKLER AND H. E. HOFF. The pharmacological actions of parenterally administered magnesium salts. A review. *Anesthesiology* 3: 323, 1942.
  39. SCOTT, J. B., E. D. FROHLICH, R. A. HARDIN AND F. J. HADDY. Na<sup>+</sup>, K<sup>+</sup>, and Mg<sup>++</sup> action on coronary vascular resistance in the dog heart. *Am. J. Physiol.* 201: 1095, 1961.
  40. KOBAYASHI, J. On geographical relationship between the chemical nature of river water and death rate from apoplexy. *Ber. Ohara Inst.* 11: 12, 1957.
  41. SCHROEDER, H. A. Municipal drinking water and cardiovascular death rates. *J. Am. Med. Assoc.* 95: 125, 1966.
  42. SCHROEDER, H. A. Relations between hardness of water and death rates from certain chronic and degenerative diseases in the United States. *J. Chronic Diseases* 12: 586, 1960.
  43. SCHROEDER, H. A. Relation between mortality from cardiovascular disease and treated water supplies. *J. Am. Med. Assoc.* 172: 1902, 1960.
  44. SCHROEDER, H. A. Response to letter. *J. Am. Med. Assoc.* 174: 1347, 1960.
  45. SCHROEDER, H. A., AND J. DURAN. Hardness of local water supplies and mortality from cardiovascular disease. *Lancet* 1: 1171, 1961.
  46. PHILLIPS, J. H., AND G. E. BURCH. Cardiovascular disease in the white and Negro races. *Am. J. Med. Sci.* 238: 97, 1959.
  47. BERSOHN, I. Atherosclerosis and coronary heart disease: possible incrimination of magnesium deficiency in their promotion. *Med. Proc.* 4: 62, 1958.
  48. BERSOHN, I., AND P. J. OELOFSE. Correlation of serum-magnesium and serum-cholesterol levels in South African Bantu and European subjects. *Lancet* 1: 1020, 1957.
  49. ALLEN, H. A. J. An investigation of water hardness, calcium and magnesium in relation to mortality in Ontario. Ph.D. Thesis, University of Waterloo, Ontario, Canada, 1972.
  50. ANDERSON, T. W., W. H. LERICHE AND J. S. MACKAY. Sudden death and ischemic heart disease. *New Engl. J. Med.* 280: 805, 1969.
  51. BJORCK, G., H. BOSTROM AND A. WIDSTROM. On the relationship between water hardness and death rate in cardiovascular diseases. *Acta Med. Scand.* 178: 239, 1965.
  52. CRAWFORD, M. D., M. J. GARDNER AND J. N. MORRIS. Changes in water hardness and local death rates. *Lancet* 2: 327, 1971.
  53. CRAWFORD, M. D., J. J. GARDNER AND J. N. MORRIS. Mortality and hardness of local water supplies. *Lancet* 1: 827, 1968.
  54. CRAWFORD, T., AND M. D. CRAWFORD. Prevalence and pathological changes of ischaemic heart-disease in a hard-water and in a soft-water area. *Lancet* 1: 229, 1967.
  55. MORRIS J. N., M. D. CRAWFORD AND J. A. HEADY. Hardness of local water-supplies and mortality from cardiovascular disease. *Lancet* 2: 506, 1962.
  56. MORRIS, J. N., M. D. CRAWFORD AND J. A. HEADY. Hardness of local water-supplies and mortality from cardiovascular disease in the county boroughs of England and Wales. *Lancet* 1: 860, 1961.
  57. PETERSON, D. R., D. J. THOMPSON AND J-M. NAN. Water hardness, arteriosclerotic heart disease and sudden death. *Am. J. Epidemiol.* 92: 90, 1970.
  58. ROBERTSON, J. S. Mortality and hardness of water. *Lancet* 2: 348, 1968.
  59. ROBERTSON, J. S. The water story. *Lancet* 1: 1160, 1969.
  60. UNSIGNED EDITORIAL. Hardness of water and cardiovascular disease. *Brit. Med. J.* 1: 1429, 1963.
  61. UNSIGNED EDITORIAL. The water story. *Lancet* 1: 1012, 1969.
  62. BERBERIAN, D. A. Cardiovascular deaths. *J. Am. Med. Assoc.* 179: 825, 1962.
  63. BROWNE, S. E. Magnesium and cardiovascular disease. *Brit. Med. J.* 2: 118, 1963.
  64. PARSONS, R. S., T. C. BUTLER AND E. P. SELLARS. Hardness of local water supplies and mortality from cardiovascular disease. *Lancet* 2: 213, 1961.
  - 64a. MUSS, D. L. Relationship between water quality and deaths from cardiovascular disease. *J. Am. Waterworks* 54: 1371, 1962.
  - 64b. LEVERTON, R. M., J. M. LEICHSENRING, H. LINKSWILER AND F. MEYER. Magnesium requirement of young women receiving controlled intakes. *J. Nutr.* 74: 33, 1961.
  65. MARIER, J. R. The importance of dietary magnesium with particular reference to humans. *Vitalstoffe Zivilisationskrankh.* 13: 144, 1968.
  66. NERI, L. C., D. HEWITT AND J. S. MANDEL. Risk of sudden death in soft water areas. *Am. J. Epidemiol.* 94: 101, 1971.
  67. BAJUSZ, E. Heart-disease and soft and hard water. *Lancet* 1: 726, 1967.
  68. SCHROEDER, H. A., A. P. NASON AND I. H. TIPTON. Essential metals in man-magnesium. *J. Chronic Diseases* 21: 815, 1968.
  69. SEELIG, M. S. The requirement of magnesium by the normal adult. *Am. J. Clin. Nutr.* 6: 342, 1964.
  70. GOLDSMITH, N. F. The contribution of hard water to the calcium and magnesium intakes of adults (relation of drinking water minerals to cardiovascular disease). *Water Resources Res. Catalogue 5*, U.S. Dept. of the Interior, Washington, D.C.: U.S. Govt. Printing Office, December 1969.



71. HANKIN, J. H., S. MARGEN AND N. F. GOLDSMITH. Contribution of hard water to calcium and magnesium intakes of adults. *J. Am. Dietet. Assoc.* 56: 212, 1970.
72. NEAL, J. B., AND M. NEAL. Effect of hard water and  $MgSO_4$  on rabbit atherosclerosis. *Arch. Pathol.* 73: 400, 1962.
73. DiGIORGIO, J., J. J. VITALE AND E. E. HELLERSTEIN. Sarcosomes and magnesium deficiency in ducks. *Biochem. J.* 82: 184, 1962.
74. HEGGTVEIT, H. A. Mitochondrial calcification in experimental magnesium deficiency. *Proc. Can. Federation Biol. Soc.* 8: 49, 1965.
75. HEGGTVEIT, H. A. The cardiomyopathy of Mg-deficiency. In: *Electrolytes and Cardiovascular Diseases*, edited by E. Bajusz. Basel: Karger, 1965. p. 204.
76. HEGGTVEIT, H. A., L. HERMAN AND R. K. MISHRA. Cardiac necrosis and calcification in experimental magnesium deficiency. *Am. J. Pathol.* 45: 757, 1964.
77. MISHRA, R. K. Studies on experimental magnesium deficiency in the albino rat. 2. Influence of Mg deficient diet on mitochondrial population of heart, kidney, and liver. *Rev. Can. Biol.* 19: 135, 1960.
78. NAKAMURA, M., M. NAKATANI, M. KOIKE, S. TORII AND M. HIRAMATSU. Swelling of heart and liver mitochondria from magnesium deficient rats and its reversal. *Proc. Soc. Exptl. Biol. Med.* 108: 315, 1961.
79. ARNOLD, R. M., AND I. H. FINCHAM. Cardiovascular and pulmonary calcification apparently associated with dietary imbalance in Jamaica. *J. Comp. Pathol.* 60: 51, 1950.
80. GREENBERG, D. M., C. E. ANDERSON AND E. V. TUFTS. Pathological changes in the tissues of rats reared on diets low in magnesium. *J. Biol. Chem.* 114: 43, 1936.
81. KO, K. W., F. X. FELLERS AND J. M. CRAIG. Observations on magnesium deficiency in the rat. *Lab. Invest.* 11: 294, 1962.
82. MISHRA, R. K. Studies on experimental magnesium deficiencies in the albino rat. 1. Functional and morphologic changes associated with low intake of Mg. *Rev. Can. Biol.* 19: 122, 1960.
83. MOORE, L. A., L. B. SHOLL AND E. T. HALLMAN. Gross and microscopic pathology associated with low blood magnesium in dairy calves. *J. Dairy Sci.* 19: 441, 1936.
84. MOORE, L. A., E. T. HALLMAN AND L. B. SHOLL. Cardiovascular and other lesions in calves fed diets low in magnesium. *Arch. Pathol.* 1: 820, 1938.
85. SELYE, H. *The Pluricausal Cardiomyopathies*. Springfield, Illinois: Thomas, 1961.
86. SELYE, H., AND E. BAJUSZ. Provocation and prevention of potassium deficiency by various ions. *Proc. Soc. Exptl. Biol. Med.* 98: 580, 1958.
87. SETA, K., E. E. HELLERSTEIN AND J. J. VITALE. Myocardium and plasma electrolytes in dietary magnesium and potassium deficiency in the rat. *J. Nutr.* 87: 179, 1965.
88. WENER, J., K. PINTAR, M. A. SIMON, R. MOTOLA, R. FRIEDMAN, A. MAYMAN AND R. SCHAUCHER. The effects of prolonged hypomagnesemia on the cardiovascular system in young dogs. *Am. Heart J.* 67: 221, 1964.
89. BAJUSZ, E. Age factor and myocardial necrosis: experimental studies on the sensitizing effect of K-, Mg- and Cl-deficiencies. *Gerontologia* 8: 66, 1963.
90. BAJUSZ, E. Experimental pathology and histochemistry of heart muscle. *Meth. Achiévm. Exptl. Pathol.* 2: 172, 1967.
91. BAJUSZ, E. AND H. SELYE. Conditioning factors for cardiac necroses. *Trans. N.Y. Acad. Sci.* 21: 659, 1959.
92. MISHRA, R. K. Studies on magnesium deficiency in the albino rat. 5. The influence of Mg-deficient regime on "steroid-phosphate-cardiopathy." *Rev. Can. Biol.* 19: 158, 1960.
93. MISHRA, R. K. Studies on experimental magnesium deficiency in the albino rat. 7. The influence of dihydrotachysterol on certain manifestations associated with Mg-deficient regime. *Rev. Can. Biol.* 19: 168, 1960.
94. MISHRA, R. K. Studies on experimental magnesium deficiency in the albino rat. 8. The influence of stress on cardiac and renal lesions in rats on Mg-deficient diet. *Rev. Can. Biol.* 19: 685, 1970.
95. MISHRA, R. K., AND L. HERMAN. Preliminary observations on the ultrastructure of rat cardiac muscle following a magnesium-deficient regime and cold stress. *Proc. European Conf. on Electron Micros. Delft, The Netherlands, 1960*, p. 907.
96. SELYE, H. *The Chemical Prevention of Cardiac Necroses*. New York: Ronald, 1958.
97. SHIMAMOTO, T., T. FUJITA, H. SHIMURA, H. YAMAZAKI, S. IWAHARA AND G. YAJIMA. Myocardial infarct-like lesions and arteriosclerosis induced by high molecular substances, and prevention by magnesium salt. *Am. Heart J.* 57: 273, 1959.
98. BAJUSZ, E., AND K. LOSSNITZER. A new disease model of chronic congestive heart failure: studies on its pathogenesis. *Trans. N.Y. Acad. Sci. (Ser. II)* 30: 939, 1968.
99. BELLER, G. A., W. B. HOOD, T. W. SMITH, W. H. ABELMANN AND W. E. C. WACKER. Prevalence of hypomagnesemia in a prospective clinical study of digitalis intoxication. *Am. J. Cardiol.* 26: 625, 1970.
100. BELLER, G. A., T. W. SMITH, W. H. ABELMANN, E. HABER AND W. B. HOOD. Digitalis intoxication: a prospective clinical study with serum level correlations. *New Engl. J. Med.* 284: 989, 1971.
101. SELLER, R. H., J. CANGIANO, K. E. KIM, S. MENDELSSOHN, A. N. BREST AND C. SWARTZ. Digitalis toxicity and hypomagnesemia. *Am. Heart J.* 79: 57, 1970.
102. SELLER, R. H., S. MENDELSSOHN, K. E. KIM AND C. D. SWARTZ. Mg sulfate in digitalis toxicity. *Am. J. Cardiol.* 25: 127, 1970.
103. VITALE, J. J., E. E. HELLERSTEIN, M.

- NAKAMURA AND B. LOWN. Effects of magnesium-deficient diet upon puppies. *Circulation Res.* 9: 387, 1961.
104. VITALE, J. J., H. VELEZ, C. GUSMAN AND P. CORREA. Magnesium deficiency in the cebus monkey. *Circulation Res.* 12: 642, 1963.
  105. KIM, Y. W., C. E. ANDREWS AND W. E. RUTH. Serum magnesium and cardiac arrhythmia with special reference to digitalis intoxication. *Am. J. Med. Sci.* 242: 87, 1961.
  106. KABELITZ, H. J. Zur Infusionstherapie mit Kalium-Magnesiumaspartat bei akutem Herzinfarkt, chronisch-insuffizientem und Digitalisintoxikation. *Med. Klin.* 63: 1267, 1968.
  107. LEVINE, H. D. Certain aspects of the biochemistry and physiology of arrhythmia. *Med. Clin. N.A.* 44: 1199, 1960.
  108. STANBURY, J. B., AND A. FARAH. Effects of the magnesium ion on the heart and on its response to digitoxin. *J. Pharm. Exptl. Therap.* 100: 445, 1950.
  109. SZEKELY, P., AND N. A. WYNNE. The effects of magnesium on cardiac arrhythmias caused by digitalis. *Clin. Sci.* 10: 241, 1951.
  110. ZWILLINGER, L. Uber die Magnesiumwirkung auf das Herz. *Klin. Wochschr.* 14: 1429, 1935.
  111. BAJUSZ, E. *Nutritional Aspects of Cardiovascular Diseases.* Philadelphia: Lippincott, 1965.
  112. BAJUSZ, E. The terminal electrolyte-shift mechanism in heart muscle; its significance in the pathogenesis and prevention of necrotizing cardiomyopathies. In: *Electrolytes and Cardiovascular Diseases.* Basel: Karger, 1965, vol. 1, p. 274.
  113. FLECKENSTEIN, A., J. JANKE AND W. JAEDICKE. Ca overload as the determinant factor in the production of catecholamine-induced myocardial lesions. *Intern. Symp. on Cardiomyopathies, S. Africa, 1971 (abstr.).*
  114. LEHR, D., AND M. KRUKOWSKI. About the mechanism of myocardial necrosis induced by sodium phosphate and adrenal corticoid overdosage. *Ann. N.Y. Acad. Sci.* 105: 135, 1963.
  115. SELYE, H. Prophylactic treatment of an experimental arteriosclerosis with magnesium and potassium salts. *Am. Heart J.* 55: 805, 1958.
  116. SELYE, H., AND R. K. MISHRA. Prevention of the "phosphate-steroid cardiopathy" by various electrolytes. *Am. Heart J.* 55: 163, 1958.
  117. LEHR, D., M. KRUKOWSKI, J. KAPLAN AND J. FILLISTI. About the protective effect of magnesium chloride in experimental myocardial necrosis. 4th Intern. Congr. Pharmacol. Basel, Switzerland, 1969.
  118. RIGO, J. The relationship between magnesium and the vascular system. First Intern. Symp. Magnesium Deficit in Human Pathology. Vittel, France, 1971, p. 213.
  119. RIGO, J., B. N. LI, T. ZELLES, I. SZELENYI AND J. SOS. The effect of a magnesium-rich diet on experimental vascular changes. *Acta Physiol. Acad. Sci. Hung.* 25 (Suppl.): 40, 1965.
  120. RIGO, J., G. SIMON, C. HEGYVARI AND J. SOS. Effect of magnesium on dietary infarctoid changes in the heart. *Acta Med. Acad. Sci. Hung.* 19: 231, 1963.
  121. RIGO, J., I. SZELENYI AND J. SOS. Bedeutung magnesiumreicher Diat fur Mensch mit Magnesiummangel. *Vitalstoffe Zivilisationskrankh.* 10: 216, 1965.
  122. BUNCE, G. E., Y. CHIEMCHAIRSRI AND PHILLIPS. The mineral requirements of the IV. Effect of certain dietary and physio factors upon the magnesium deficiency syndrome. *J. Nutr.* 76: 23, 1962.
  123. COLBY, R. W., AND C. M. FRYE. Effect of feeding various levels of calcium, potassium magnesium to rats. *Am. J. Physiol.* 166: 1951.
  124. NUGARA, D., AND H. M. EDWARDS. Effect of calcium and phosphorus on magnesium metabolism in chicks. *Federation Proc.* 20: 1961 (abstr.).
  125. NUGARA, D., AND H. M. EDWARDS. Influence of dietary Ca and P levels on the requirements of the chick. *J. Nutr.* 80: 1963.
  126. O'DELL, B. L. Magnesium requirement and relation to other dietary constituents. *Federation Proc.* 19: 648, 1960.
  127. O'DELL, B. L., E. R. MORRIS AND W. REGAN. Magnesium requirement of guinea pigs and rats. Effects of calcium and phosphorus symptoms of magnesium deficiency. *J. Nutr.* 103, 1960.
  128. VITALE, J. J., E. E. HELLERSTEIN, D. HEGSTED, M. NAKAMURA AND A. FALMAN. Studies on the interrelationships between dietary magnesium and calcium in atherogenic and renal lesions. *Am. J. Clin. Nutr.* 7: 13, 1961.
  129. COLBY, R. W., AND C. M. FRYE. Effect of feeding high levels of protein and calcium in rations on magnesium deficiency syndrome. *Am. J. Physiol.* 166: 408, 1951.
  130. RIGO, J., I. BUDAVARI AND J. SOS. Potassium, sodium, magnesium and calcium levels in rats during alimentary provocation of infarctoid cardiac lesions. *Acta Med. Acad. Sci. Hung.* 185, 1961.
  131. SOS, J., J. RIGO, T. KEMENY AND T. TA. Infarctoid cardiac lesions induced by dietary factors in the cock. *Acta Med. Acad. Sci. Hung.* 20: 9, 1964.
  132. SOS, J., T. GATI, T. KEMENY AND J. RIGO. Infarctoid cardiac lesions induced by dietary factors in the dog. *Acta Med. Acad. Sci. Hung.* 20: 1, 1964.
  133. SOS, J., J. RIGO AND T. GATI. The effect of aspartates on experimental hypertension, myocardial lesions and serum electrolyte contents in rats. *Arzneimittel-Forsch.* 14: 1134, 1964.
  134. LEHR, D. Tissue electrolyte alteration in disseminated myocardial necrosis. *Ann. N. Y. Acad. Sci.* 156: 344, 1969.
  135. LEHR, D. The role of certain electrolytes and hormones in disseminated myocardial necrosis. In: *Electrolytes and Cardiovascular Diseases* edited by E. Bajusz. Basel: Karger, 1965, vol.

- p. 248.
136. LEHR, D., M. KRUKOWSKI AND R. CHAU. Acute myocardial injury produced by sympathomimetic amines. *Israel J. Med. Sci.* 5: 519, 1969.
  137. LEHR, D., M. KRUKOWSKI AND R. COLON. Correlation of myocardial and renal necrosis with tissue electrolyte change. *J. Am. Med. Assoc.* 197: 105, 1966.
  138. FLECKENSTEIN, A. Specific inhibitors and promoters of calcium action in the excitation-contraction coupling of heart muscle in their role in the prevention or production of myocardial lesions. In: *Calcium and the Heart*, edited by P. Harris and L. Opie. New York: Academic, 1971, p. 135.
  139. FLECKENSTEIN, A., H. J. DOERING AND O. LEDER. The significance of high-energy phosphate exhaustion in the etiology of isoproterenol-induced cardiac necrosis and its prevention by Iproveratril, Compound D600 or Prenylamine. In: *Symposium International on Drugs and Metabolism of Myocardium and Striated Muscle*, edited by M. Larmarche and R. Royer. Nancy, France, 1969.
  140. FLECKENSTEIN, A., J. JANKE AND H. J. DOERING. Myocardial Fiber Necrosis due to Intracellular Ca-Overload: A New Principle in Cardiac Physiology. Fifth Annual Meeting of Intern. Study Group for Research in Cardiac Metabolism. Winnipeg, Canada, 1972, p. 52.
  141. COVINO, B. G., AND A. H. HEGNAUER. Electrolytes and pH changes in relation to hypothermic ventricular fibrillation. *Circulation Res.* 3: 575, 1955.
  142. DIETZMAN, D. E., C. P. PAGE, W. J. DEATON, L. A. GEDDES AND H. E. HOFF. The sympathetic component of the respiratory-heart rate response in calcium intoxication. *Arch. Intern. Pharmacodyn.* 162: 478, 1966.
  143. FUKUDA, Y-I. Multiple firing of frog's ventricle in response to a single stimulus in Ringer's solution with excess calcium. *Japan. J. Physiol.* 20: 42, 1970.
  144. HADDY, F. J. Ionic action on blood vessels. *Biochem Clin.* 1: 29, 1963.
  145. HADDY, F. J., AND J. B. SCOTT. Effects of electrolytes and water upon resistance to blood flow through intact vascular beds. In: *Electrolytes and Cardiovascular Diseases*, edited by E. Bajusz. Basel: Karger, 1965, vol. 2, p. 383.
  146. HADDY, F. J., J. B. SCOTT, M. A. FLORIO, R. M. DAUGHERTY AND D. N. HUIZENGA. Local vascular effects of hypokalemia, alkalosis, hypercalcemia and hypomagnesemia. *Am. J. Physiol.* 204: 202, 1963.
  147. ELEK, S. R., AND L. N. KATZ. Further observations on the action of drugs on coronary vessel caliber: paterdrine, angiotonin, renin, quinidine, insulin, magnesium sulphate, morphine, acid and alkali. *J. Pharm. Exptl. Therap.* 75: 178, 1942.
  148. SEEKLES, L., B. SJOLLEMA AND J. C. VANDERKAY. *Tydschr. v. diergenesk* 57: 1229, 1930 (cited by Boyd and Scherf (150)).
  149. SJOLLEMA, B., AND L. SEEKLES. Der Magnesiumgehalt des Blutes, besonders bei Tetanie. *Klin. Wochschr.* 11: 989, 1932 (Nutr. Abstr. 2: 291, 1932).
  150. BOYD, L. J., AND D. SCHERF. Magnesium sulfate in paroxysmal tachycardia. *Am. J. Med. Sci.* 206: 43, 1943.
  151. SZEKELY, P. The action of magnesium on the heart. *Brit. Heart J.* 8: 115, 1946.
  152. AGRANAT, A. L. Parenteral magnesium sulphate in the treatment of angina pectoris. *Med. Proc.* 4: 67, 1958.
  153. FEEDMAN, H. Parenteral magnesium sulphate in coronary disease. *S. African Med. J.* 32: 392, 1958.
  154. MALKIEL-SHAPIRO, B. Further observations on parenteral magnesium sulphate therapy in coronary heart disease: a clinical appraisal. *S. African Med. J.* 32: 1211, 1958.
  155. MALKIEL-SHAPIRO, B., AND I. BERSOHN. Magnesium sulphate in coronary thrombosis. *Brit. Med. J.* 1: 292, 1960.
  156. MALKIEL-SHAPIRO, B., I. BERSOHN AND P. E. TERNER. Parenteral magnesium sulphate therapy in coronary heart disease. A preliminary report on its clinical and laboratory aspects. *Med. Proc.* 2: 455, 1956.
  157. MARIAS, A. F. Magnesium sulphate in coronary artery disease. *Med. Proc.* 4: 66, 1958.
  158. PARSONS, R. S. The biochemical changes associated with coronary artery disease treated with magnesium sulphate. *Med. J. Australia* 1: 883, 1958.
  159. PARSONS, R. S., T. L. BUTLER AND E. P. SELLARS. Coronary artery disease. *Med. Proc.* 6: 479, 1960.
  160. PARSONS, R. S., T. BUTLER AND E. P. SELLARS. The treatment of coronary artery disease. *Med. Proc.* 5: 487, 1959.
  161. TEEGER, A. Magnesium sulphate in coronary artery disease. *Case Records. Med. Proc.* 4: 77, 1958.
  162. PERLIA, A. N. Experience with treatment of angina pectoris by i.v. infusion of magnesium sulphate. *Sovetsk Med. (transl.)* 20: 63, 1958.
  163. SAVENKOV, P. M., A. K. MARTYNOV, G. I. KERTSMAN, O. B. BOBROOSKAYA AND A. D. POGORELSKY. The use of magnesium composition in patients with atherosclerosis of vessels of the heart, brain, and lower extremities. *Kardiologia* 11: 85, 1971.
  164. KANTHER, R. Compensation of hypoxia in the human heart muscle by means of potassium magnesium aspartate. In: *Electrolytes and Cardiovascular Diseases*, edited by E. Bajusz. Basel: Karger, 1966, vol. 2, p. 324.
  165. KENTER, H., AND A. FALKENHAHN. Management of myocardial infarction with potassium magnesium aspartate (clinical observations). In: *Electrolytes and Cardiovascular Diseases*, edited by E. Bajusz. Basel: Karger, 1966, vol. 2, p. 420.
  166. KOHLER, U. Modern therapy of angina pectoris and prevention of myocardial infarction by

- means of transcardiac iontophoresis. In: *Electrolytes and Cardiovascular Diseases*, edited by E. Bajusz. Basel: Karger, 1966, vol. 2, p. 395.
167. KUCHER, E. Iontophoretic cardiac therapy with magnesium and potassium chloride. In: *Electrolytes and Cardiovascular Diseases*, edited by E. Bajusz. Basel: Karger, 1966, vol. 2, p. 407.
  168. LABORIT, H. New physiological concepts of cardiovascular functions. Therapeutic consequences. In: *Electrolytes and Cardiovascular Diseases*, edited by E. Bajusz. Basel: Karger, 1966, vol. 2, p. 239.
  169. LARCAN, A. Pathophysiological basis and practical application of a "metabolic" therapy of myocardial infarction. In: *Electrolytes and Cardiovascular Diseases*, edited by E. Bajusz. Basel: Karger, 1966, vol. 2, p. 277.
  170. MATE, K., G. BIRTALAN, I. HORVATH, V. NEMES, E. LOWEY AND E. BENEDEK. Clinical experiences in the application of electrolytes in cardiopathies. In: *Electrolytes and Cardiovascular Diseases*, edited by E. Bajusz. Basel: Karger, 1966, vol. 2, p. 260.
  171. MELON, J. M. Essais cliniques avec l'aspartate de potassium et de magnesium dans les affections cardiovasculaires. *Rev. Agress.* 1: 443, 1960.
  172. NIEPER, H. A., AND K. BLUMBERGER. Electrolyte transport therapy of cardiovascular diseases. In: *Electrolytes and Cardiovascular Diseases*, edited by E. Bajusz. Basel: Karger, 1966, vol. 2, p. 141.
  173. PILLEN, D. Experiences with potassium magnesium aspartate. In: *Electrolytes and Cardiovascular Diseases*, edited by E. Bajusz. Basel: Karger, 1966, vol. 2, p. 386.
  174. PILLEN, D. Zur Pathogenese, Prophylaxe und Therapie des Herzinfarktes. *Med. Klin.* 33: 1413, 1962.
  175. SIMON, H. Die Rolle des Magnesiums bei Atherosklerose und Herzinfarkt. *Vitalstoffe Zivilisationskrankh.* 11: 202, 1966.
  176. STEPANTSCHITZ, G., AND E. FROHLICH. Vorlaufige Mitteilung uber Verwendung sogenannter Elektrolytschlepper bei Myokardinfarkt. *Wein Med. Wochschr.* 117: 884, 1967.
  177. THURNHERR, V. A., AND J. KOCH. Versuch einer Kausaltherapie der Arteriosklerose mit einer Kombination von Hyaluronidase und Magnesium. *Schweiz. Med. Wochschr.* 92: 949, 1962.
  178. ANSTALL, H. B., R. G. HUNTSMAN, H. LEHMANN, G. H. HAYWARD AND D. WEITZMAN. The effect of magnesium on blood coagulation in human subjects. *Lancet* 1: 814, 1959.
  179. BROWNE, S. E. Magnesium for atherosclerosis. *Brit. Med. J.* 2: 629, 1964.
  180. BROWNE, S. E. Magnesium sulphate in the treatment of angina. *Lancet* 2: 1313, 1961.
  181. BROWNE, S. E. Parenteral magnesium sulphate in arterial disease. *Practitioner* 192: 791, 1964.
  182. HUNTSMAN, R. G., G. A. L. HURN AND H. LEHMANN. Observations on the effect of magnesium on blood coagulation. *J. Clin. Pathol.* 13: 99, 1960.
  183. TONKS, R. S. Haematology-magnesium, adenosine diphosphate and blood platelets. *Nature* 210: 106, 1966.
  184. HOFFMANN, L., AND R. SIEGEL. Die Behandlung von Kreislauffstörungen mit Magnesiumverbindungen. *Hippokrates* 23: 387, 1952 (cited by Lossnitzer (23)).
  185. CHARNOCK, J. S., J. CASLEY-SMITH AND C. J. SCHWARTZ. Serum magnesium cholesterol relationships in the central Australian aborigine and in Europeans with and without ischaemic heart disease. *Australian J. Exptl. Biol.* 37: 509, 1959.
  186. DE LOS RIOS, M. G. Serum magnesium and serum cholesterol changes in man. *Am. J. Clin. Nutr.* 9: 315, 1961.
  187. JANKELSON, O. M., J. J. VITALE AND D. M. HEGSTED. Serum magnesium cholesterol and lipoproteins in patients with atherosclerosis and alcoholism. *Am. J. Clin. Nutr.* 7: 23, 1959.
  188. KRUSE, H. D., E. R. ORENT AND E. V. McCOLLUM. Studies on magnesium deficiency in animals. III. Chemical changes in the blood following magnesium deprivation. *J. Biol. Chem.* 100: 603, 1933.
  189. HELLERSTEIN, E. E., M. NAKAMURA, D. M. HEGSTED AND J. J. VITALE. Studies on the interrelationships between dietary magnesium, quality and quantity of fat, hypercholesterolemia and lipidosis. *J. Nutr.* 71: 339, 1960.
  190. NAKAMURA, M., Y. ISHIHARA, T. SATA, S. TORII, A. SUMIYOSHI AND K. TANAKA. Effects of dietary magnesium and glycyrrhizin on experimental atheromatosis of rats. *Japan. Heart J.* 7: 474, 1966.
  191. NAKAMURA, M., S. TORII, M. HIRAMATSU, J. HIRANO, A. SUMIYOSHI AND K. TANAKA. Dietary effect of magnesium on cholesterol-induced atherosclerosis of rabbits. *J. Atheroscler. Res.* 5: 145, 1965.
  192. NAKAMURA, M., J. J. VITALE, D. M. HEGSTED AND E. E. HELLERSTEIN. The effect of dietary magnesium and thyroxine on progression and regression of cardiovascular lipid deposition in the rat. *J. Nutr.* 71: 347, 1960.
  193. VITALE, J. J., P. L. WHITE, M. NAKAMURA, D. M. HEGSTED, N. ZAMCHECK AND E. E. HELLERSTEIN. Interrelationships between experimental hypercholesterolemia, magnesium requirement and experimental atherosclerosis. *J. Exptl. Med.* 106: 757, 1957.
  194. BHATTACHARYYA, N. K., AND D. N. MULLICK. Effects of drenching with magnesium carbonate suspension on the body weight and on magnesium and cholesterol content in serum of rabbits receiving basal diet supplemented by 15% Ghee. *Curr. Sci.* 16: 490, 1964.
  195. BHATTACHARYYA, N. K., AND D. N. MULLICK. Effect of magnesium sulfate injection in experimental hypercholesterolemia in rabbits. Part I. On the serum and tissue cholesterol. *Ann. Biochem. Exptl. Med.* 23: 515, 1963.

196. MULLICK, D. N., AND K. B. KAKKAR. Effect of supplementing magnesium salt in the milk diet on the growth rate and serum composition in young rats. *Indian J. Med. Res.* 51: 742, 1963.
197. ADAMS, C. W. M., O. B. BAYLISS, A. M. IBRAHIM AND W. A. G. ROPER. Failure of oral magnesium salts to prevent aortic atheroma, hepatic lipid accumulation and hypercholesterolaemia in the cholesterol-fed rabbit. *J. Atheroscler. Res.* 4: 283, 1964.
198. HACKETHAL, K. H. Aussprache zu den Vortragen I und II. *Chirurgie* 270: 35, 1951.
199. HACKETHAL, K. H. Vorläufige Mitteilung über den Einfluss des Magnesiums auf die Fibrinolyse. *Klin. Wochschr.* 27: 315, 1949.
200. HEINRICH, H. G. Prophylaxe und Therapie thrombotischer Zustände mit Magnesium. *Z. Gesell. Inn. Med.* 12: 777, 1957.
201. MARX, R., AND CHR. HILLER. Blutsalze und Fibrinolyse im Menschliche Serum. *Klin. Wochschr.* 30: 71, 1952.
202. SCHNITZLER, B. Thromboseprophylaxe mit Magnesium. *Munch. Med. Wochschr.* 99: 81, 1957.
203. DURLACH, J. Le rôle antithrombotique physiologique du magnésium. *Coeur Medicine Interne.* 6: 213, 1967.
204. DURLACH, J. Pilule et thrombose (des plaquettes, des estrogènes et du magnésium). *Rev. Franc. Endocrinol. Clin.* 11: 45, 1970.
205. ARDLIE, N. G., E. E. NISIZAWA AND M. GUCCIONE. Effect of Ca and Mg on platelet function. *Federation Proc.* 29: 423, 1970 (abstr.).
206. GOLDSMITH, N. F., AND J. P. BAUMBERGER. Mineral changes after norethynodrel. *Lancet* 2: 567, 1967.
207. GOLDSMITH, N. F., AND J. R. GOLDSMITH. Epidemiological aspects of magnesium and calcium metabolism. *Arch. Environ. Health* 12: 607, 1966.
208. GOLDSMITH, N. F., H. HUGGEL AND C. A. BOUBIER. The effects of norethynodrel with mestranol (Enovid) on serum cations and blood clotting in the rat. *Ann. Soc. Suisse Zool.* 73: 571, 1966.
209. GOLDSMITH, N. F., N. PACE, J. P. BAUMBERGER AND H. URY. Magnesium and citrate during the menstrual cycle: effect of an oral contraceptive on serum magnesium. *Fertility Sterility* 21: 292, 1970.
210. GREVILLE, G. D., AND H. LEHMANN. Cation antagonism in blood coagulation. *J. Physiol.* 103: 175, 1944.
211. UNSIGNED EDITORIAL. Magnesium and coronary disease. *Brit. Med. J.* 1: 1949, 1960.
212. STEVENSON, M. M., AND I. I. YODER. Studies of platelet aggregation, plasma adenosine diphosphate breakdown and blood coagulation in magnesium-deficient calves and rats. *Thromb. Diath. Haemorrhag.* 23: 299, 1972.
213. SZELENYI, I., R. RIGO, B. O. AHMEN AND J. SOS. The role of magnesium in blood coagulation. *Thromb. Diath. Haemorrhag.* 18: 626, 1967.
214. SZELENYI, I. Physiological interrelationship between magnesium and heart. *First Intern. Symp. Magnesium Deficit in Human Pathology.* Vittel, France, 1971, p. 95.
215. RICHARDSON, J. A., W. D. HUFFINES AND L. G. WELT. The effect of coincident hypercalcemia and potassium depletion on the rat kidney. *Metab. Clin. Exptl.* 12: 560, 1963.
216. RICHARDSON, J. A., AND L. G. WELT. The hypomagnesemia of vitamin D administration. *Proc. Soc. Exptl. Biol. Med.* 118: 512, 1965.
217. WALLACH, S., J. V. BELLAVIA AND P. J. GAMPONIA. Effect of acute and chronic hypercalcemia on cellular cation transport. *Clin. Res.* 12: 465, 1964.
218. WALLACH, S., J. V. BELLAVIA, J. SCHORR AND P. J. GAMPONIA. Effect of vitamin D on tissue distribution and transport of electrolytes Ca and Mg. *Endocrinology* 79: 773, 1966.
219. WELT, L. G. Experimental magnesium depletion. *Yale J. Biol. Med.* 36: 325, 1964.
220. HELLERSTEIN, E. E., J. J. VITALE, P. L. WHITE, D. M. HEGSTED, N. ZAMCHECK AND M. NAKAMURA. Influence of dietary magnesium on cardiac and renal lesions of young rats fed an atherogenic diet. *J. Exptl. Med.* 106: 767, 1957.
221. OLSON, E. J., AND H. E. PARKER. Effects of dietary cholesterol on skin lesions of rats with subacute magnesium deficiencies. *J. Nutr.* 83: 73, 1964.
222. RADEMEYER, L. J., AND J. BOOYENS. The effects of variations in the fat and carbohydrate content of the diet on the levels of magnesium and cholesterol in the serum of white rats. *Brit. J. Nutr.* 19: 153, 1965.
223. VITALE, J. J., P. L. WHITE, M. NAKAMURA AND D. M. HEGSTED. Effect of feeding an atherogenic diet on magnesium requirement. *Federation Proc.* 16: 400, 1957.
224. SEELIG, M. C. Are American children still getting an excess of vitamin D? *Clin. Pediat.* 9: 380, 1970.
225. SEELIG, M. S. Vitamin D and cardiovascular, renal and brain damage in infancy and childhood. *Ann. N. Y. Acad. Sci.* 147: 537, 1969.
226. SEELIG, M. S. Hyper-reactivity to vitamin D. *Med. Counterpoint* 2: 28, 1970.
227. SEELIG, M. S. Electrographic patterns of magnesium depletion appearing in alcoholic heart disease. *Ann. N. Y. Acad. Sci.* 162: 906, 1969.
228. SEELIG, M. S. Human requirements of magnesium; factors that increase needs. *First Intern. Symp. on Magnesium Deficit in Human Pathology*, edited by J. Durlach. Paris: Vittel, 1971, p. 11.